

Article number: 0101212  
 Description: Retaining ring A 370 DIN 471  
 Spring steel  
 Note: Fitted with ZGA pilers

## Measures

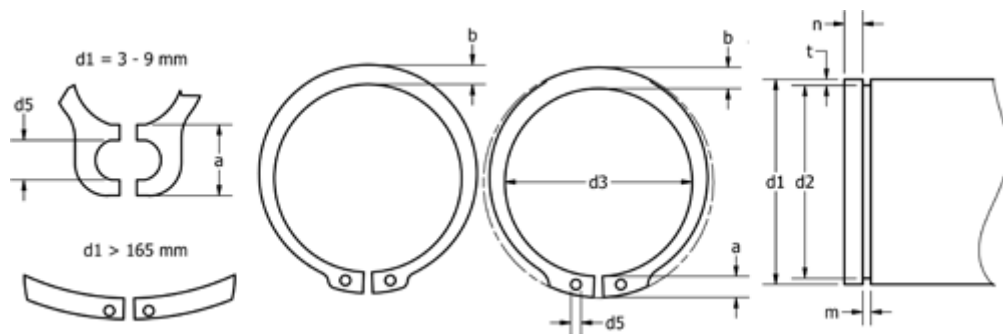

a max	=	FN kN	= 955.0	s	= 6.00
AN mm <sup>2</sup>	= 5730.0	FRg kN	= 73.00	t	= 5.00
b	= 20.0	FR kN	= 856.00	tol	= -0.89
d1	= 370	g	= 7.0	tol	= -0.15
d2	= 360.0	K kN-mm	= 1962.00	tol	= +0,90-2,00
d3	= 353.0	m min	= 6.20	Tong	= ZGA-6
d5 min	= 6.0	n abl x 1000	= 1.0	Weight kg/1000	= 890.000
Description	= A370	Nominal drive	= 15.0		